



DIRECT MOUNTING



YOKE MOUNTING



NAME: LED ShoeBox Light

P/N: SNC-SB-480W-111X-1601

Note: The Letter X in P/N stands for

- 1: ADJUSTABLE FITTER MOUNTING
- 2: DIRECT MOUNTING
- 3: YOKE MOUNTING

Advantage:

- UL cUL DLC certificate
- Philips Lumileds Chip, high CRI
- Mean Well IP65 driver, input voltage 100-277VAC
- No UV or IR in the beam
- Easy to install and operate
- Energy saving, long lifespan
- Light is soft and uniform, safe to eyes
- Instant start, NO flickering, NO humming
- Green and eco-friendly without mercury.

Application:

- 1. Outdoor basketball court, tennis court.
- 2. Badminton court, the football field.
- 3. The school playground, stadium.
- 4. Community leisure entertainment plaza, road lamp etc.

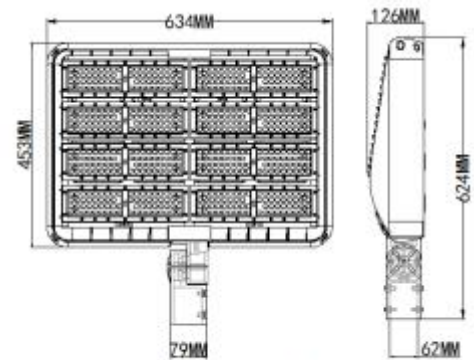

ADJUSTABLE FITTER MOUNTING

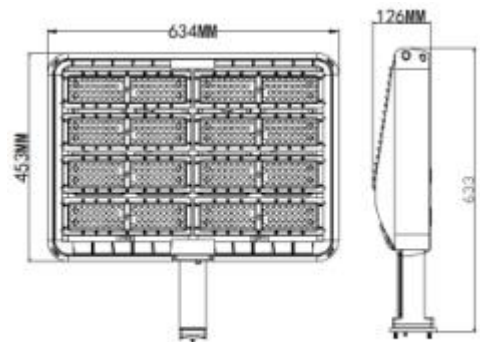

DIRECT MOUNTING

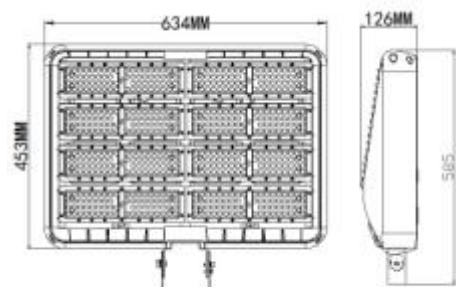

YOKE MOUNTING



Product Specifications

Product name	LED Shoe Box Light		
Light Type	Shoe Box Light		
Part No	SNC-SB-480W-1111-1601	SNC-SB-480W-1112-1601	SNC-SB-480W-1113-1601
Dimension	624*634*126mm	633*634*126mm	585*634*126mm

Technical Characteristic

Color temperature	4000K	5000K	5700K
CRI	>70		
Lumen	60000-64800LM		
Lumen Efficacy	125-135 LM/W		
Input Power	480W		
Viewing Angle	150*85 Degree (Type III)		
Input Voltage	100-277Vac 50/60Hz		
Driver model	HLG-240H-48A (2PCS)		
PFC	>0.9		
Waterproof Rating	IP65		

Materials

LED Brand	PHILIPS LUMILEDS
LED Type	LUXEON 3030 2D (1.5W)
LED QTY	560 PCS
Optional Accessory	Photocell Surge protector
Housing	Magnesium + Aluminum
Housing color	Black
Operating Temperature	-20℃ TO 45℃
Operating Humidity	20%-90% RH
Storage Temperature	-30℃ TO 80℃

Others

Storage Humidity	10%-95%
Application	Outdoor
Safety Certification	UL、cUL、DLC
Warranty Time	5 Years

Light Distribution Testing Parameters

DATA OF LAMP		PHOTOMETRIC DATA Eff: 129.59 lm/W			
MODEL		I _{max} (cd)	26713	S/MH (C0/180)	1.67
NOMINAL POWER (W)	480	LOR (%)	100.0	S/MH (C90/270)	2.06
RATED VOLTAGE (V)	120	TOTAL FLUX (lm)	60853	η UP, DN (C0-180)	0.1, 42.8
NOMINAL FLUX (lm)	60852.9	CIE CLASS	DIRECT	η UP, DN (C180-360)	0.1, 56.9
LAMPS INSIDE	1	η up (%)	0.2	CIBSE SHR NOM	1.50
TEST VOLTAGE (V)	120.0	η down (%)	99.8	CIBSE SHR MAX	1.55

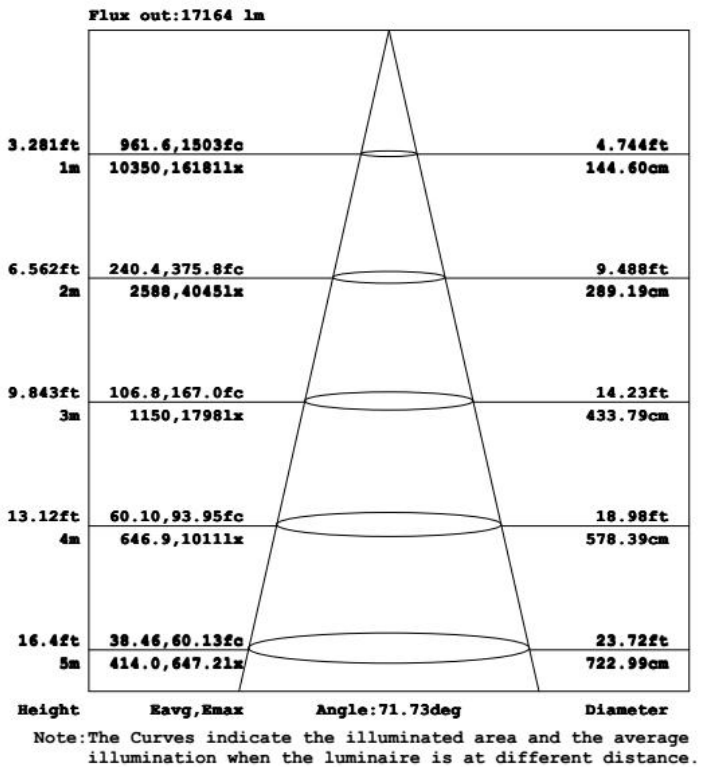
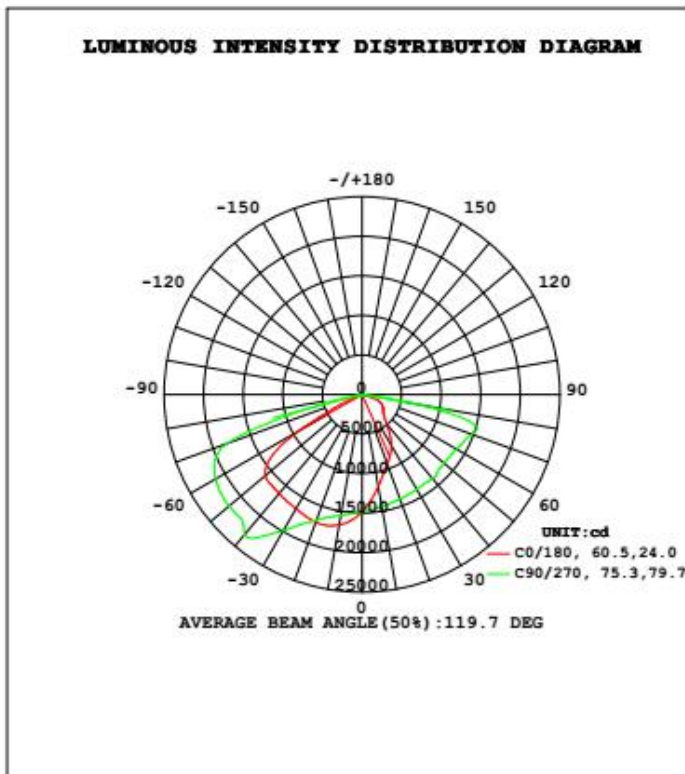

Package

	Lamps Net Weight	Size	Qty/Carton	Weight/Carton
SNC-SB-480W-1111-1601	17.5KG	715*705*195mm	1	20.5KG
SNC-SB-480W-1112-1601	17KG	715*705*195mm	1	20KG
SNC-SB-480W-1113-1601	17KG	715*705*195mm	1	20KG

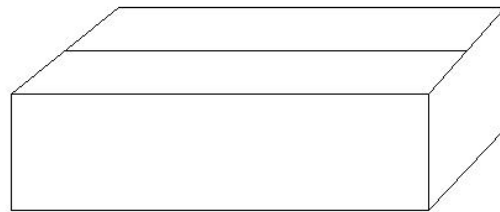
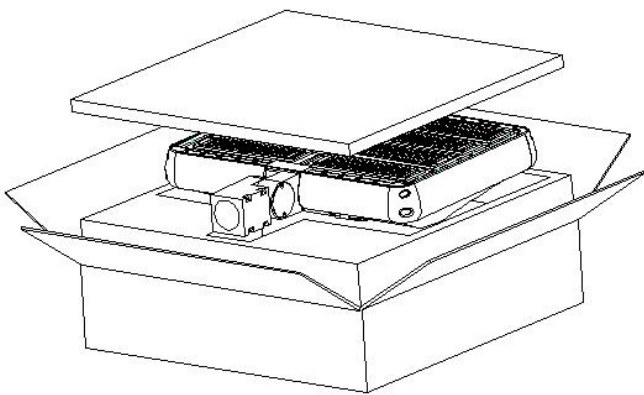

Notice For User

- ◆ Please turn off power before install or change assembly parts.
- ◆ The input voltage and lamps should be matched, after connecting the power line, Please make sure the wiring section is insulated.
- ◆ No-professionals, must not install and disassemble the lamps.

Trouble Shootings

Troubles	Check points
Flickering of the light	Turn off the power and turn on again in 3 minutes. If same phenomena occur, then call agencies
Out of working	Please check the connection