

# Stadium Series LED Sports Light



Special mould  
Generation 1

**Specification:**

- AL1070 Pure Aluminum Housing(cold forging Technology)
- IK10 strong protection, good optical function
- Waterproof: IP65
- Life Span: > 50,000 Hours
- Operating Temperature: -20-50°C
- Storage Temperature: -40-60°C

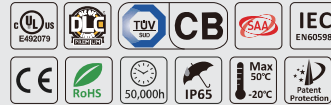

• Driver Brand: **MW** MEAN WELL

• LED Brand: **LUMILEDS**



**Laser Sight**



The laser sight is mounted on the lamp.



• **Perfect Heatsink**  
Pure Aluminum cold forging Technical Light Weight but perfect heatsink.



• **Bracket**  
Bending Bracket design make more stronger.



240W



360W



480W/500W



720W



960W/1000W

**Application:** Replace MHL400W,500W,600W,800W,1000W,1500W,2000W.

Code	Power	Lumen	CCT	CRI	Weight	Beam Angle
BR-FL240W-07(ID:FA)	240W	120Lm/w	3000K	>80	11.30	30° / 60°100°
BR-FL240W-07(ID:FA)	240W	125Lm/w	4000K	>80	11.30	30° / 60°100°
BR-FL240W-07(ID:FA)	240W	130Lm/w	5700K	>80	11.30	30° / 60°100°

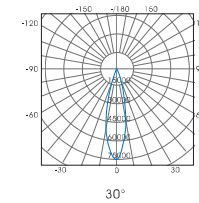
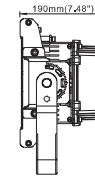
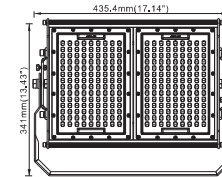

30°

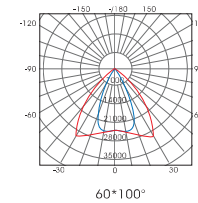

60°100°

Code	Power	Lumen	CCT	CRI	Weight	Beam Angle
BR-FL360W-07(ID:FA)	360W	120Lm/w	3000K	>80	15.00	30° / 60°100°
BR-FL360W-07(ID:FA)	360W	125Lm/w	4000K	>80	15.00	30° / 60°100°
BR-FL360W-07(ID:FA)	360W	130Lm/w	5700K	>80	15.00	30° / 60°100°

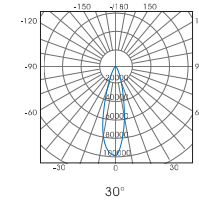
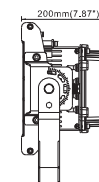
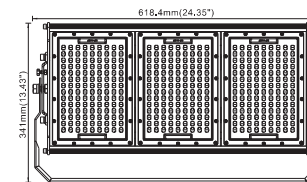

30°

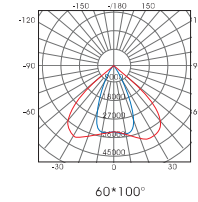

60°100°

## Stadium Series LED Sports Light

Code	Power	Lumen	CCT	CRI	Weight	Beam Angle
BR-FL500W-07(ID:FA)	500W	120Lm/w	3000K	>80	19.20	30° / 60°*100°
BR-FL500W-07(ID:FA)	500W	125Lm/w	4000K	>80	19.20	30° / 60°*100°
BR-FL500W-07(ID:FA)	500W	130Lm/w	5700K	>80	19.20	30° / 60°*100°

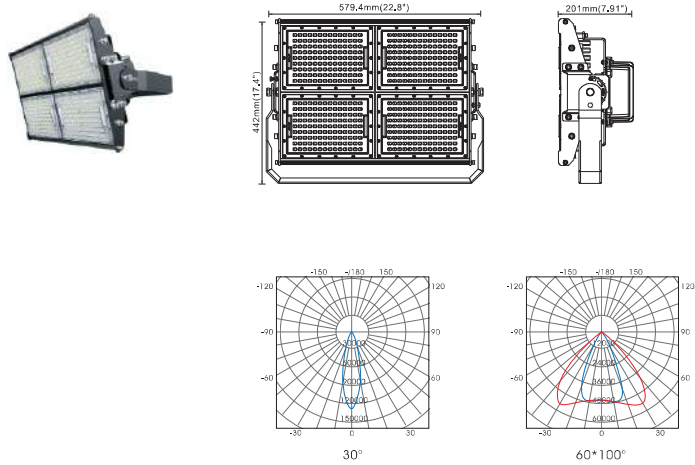

Code	Power	Lumen	CCT	CRI	Weight	Beam Angle
BR-FL720W-07(ID:FA)	720W	120Lm/w	3000K	>80	30.00	30° / 60°*100°
BR-FL720W-07(ID:FA)	720W	125Lm/w	4000K	>80	30.00	30° / 60°*100°
BR-FL720W-07(ID:FA)	720W	130Lm/w	5700K	>80	30.00	30° / 60°*100°

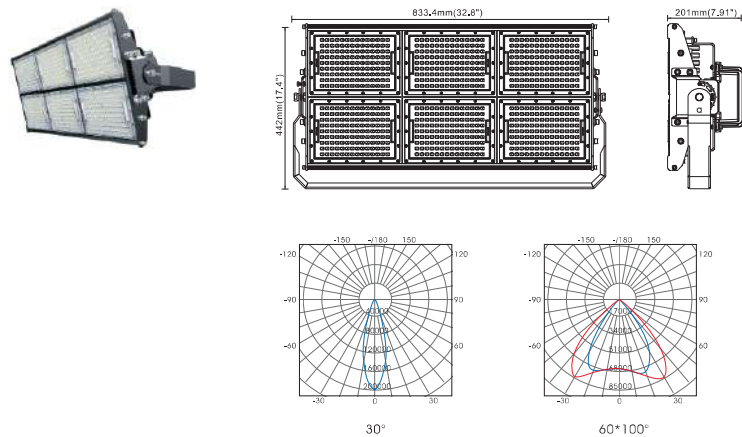

Code	Power	Lumen	CCT	CRI	Weight	Beam Angle
BR-FL1000W-07(ID:FA)	1000W	120Lm/w	3000K	>80	36.00	30° / 60°*100°
BR-FL1000W-07(ID:FA)	1000W	125Lm/w	4000K	>80	36.00	30° / 60°*100°
BR-FL1000W-07(ID:FA)	1000W	130Lm/w	5700K	>80	36.00	30° / 60°*100°

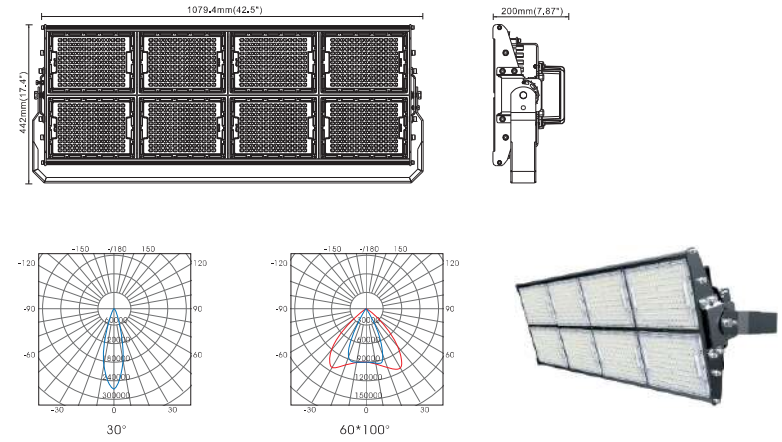

# Stadium Series LED Sports Light

## Stadium Series 07 FB SportsLight



### Specification:

- AL1070 Pure Aluminum Housing(cold forging Technology)
- IK10 strong protection, good optical function
- Waterproof: IP65
- Life Span: >50,000 Hours
- Operating Temperature: -20-50°C
- Storage Temperature: -40-60°C

Driver Brand:

LED Brand:



Black



Laser Sight



The Laser sight is mounted on the lamp.



• Perfect Heatsink  
Pure Aluminum cold forging Technical Light Weight but perfect heatsink.



• Bracket  
Bending Bracket design make more stronger.



240W



360W



480W/500W



720W



960W/1000W

Application: Replace MHL400W,500W,600W,800W,1000W,1500W,2000W.

Code	Power	Lumen	CCT	CRI	Weight	Beam Angle
BR-FL240W-07(ID:FB)	240W	120Lm/w	3000K	>80	11.30	120°
BR-FL240W-07(ID:FB)	240W	125Lm/w	4000K	>80	11.30	120°
BR-FL240W-07(ID:FB)	240W	130Lm/w	5700K	>80	11.30	120°

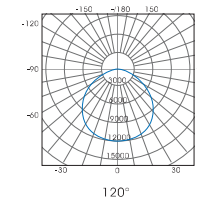
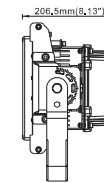
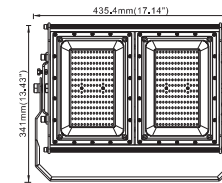

Code	Power	Lumen	CCT	CRI	Weight	Beam Angle
BR-FL360W-07(ID:FB)	360W	120Lm/w	3000K	>80	15.00	120°
BR-FL360W-07(ID:FB)	360W	125Lm/w	4000K	>80	15.00	120°
BR-FL360W-07(ID:FB)	360W	130Lm/w	5700K	>80	15.00	120°

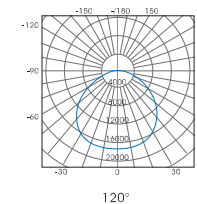
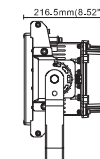
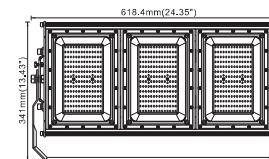



## Stadium Series LED Sports Light

Code	Power	Lumen	CCT	CRI	Weight	Beam Angle
BR-FL500W-07(ID:FB)	500W	120Lm/w	3000K	>80	19.20	120°
BR-FL500W-07(ID:FB)	500W	125Lm/w	4000K	>80	19.20	120°
BR-FL500W-07(ID:FB)	500W	130Lm/w	5700K	>80	19.20	120°

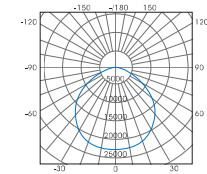
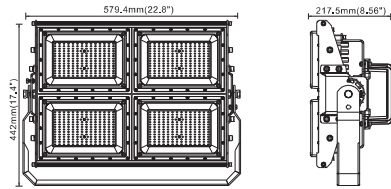

120°

Code	Power	Lumen	CCT	CRI	Weight	Beam Angle
BR-FL720W-07(ID:FB)	720W	120Lm/w	3000K	>80	30.00	120°
BR-FL720W-07(ID:FB)	720W	125Lm/w	4000K	>80	30.00	120°
BR-FL720W-07(ID:FB)	720W	130Lm/w	5700K	>80	30.00	120°

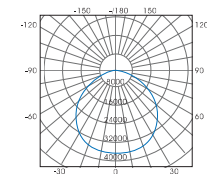
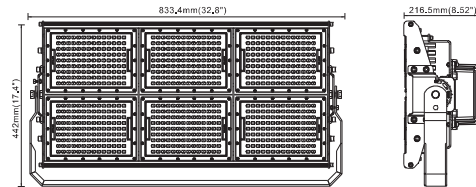

120°

Code	Power	Lumen	CCT	CRI	Weight	Beam Angle
BR-FL1000W-07(ID:FB)	1000W	120Lm/w	3000K	>80	36.00	120°
BR-FL1000W-07(ID:FB)	1000W	125Lm/w	4000K	>80	36.00	120°
BR-FL1000W-07(ID:FB)	1000W	130Lm/w	5700K	>80	36.00	120°

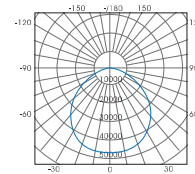
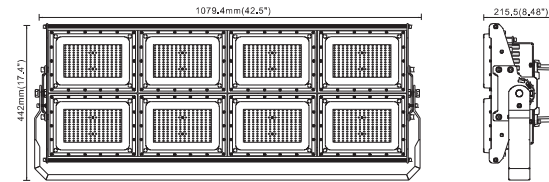

120°

