

CLP-3040
Area LED Luminaire
DESIGN-FUNCTION-QUALITY



Crystal Lighting Corp.



CLP-3040 Series. LED Area or Flood Fixture, Suitable for Wet locations. Perfect for lighting up Residential Exteriors, Walkways, Entry Ways, Perimeters, Storage Areas, Parking Garages, School Campuses, Industrial & Commercial Spaces, Parking Lots, Recreational Parks. This fixture has a wide light distribution. 10 year/100,000 hour limited warranty.

FEATURES

- Energy Savings: Over 66% compared to HID light sources.
- Improved lumen maintenance.
- High efficient Lumiled LED's.
- Operating temperatures: -30°C ~ 60°C.
- Driver: Constant current, 120-277V, 50/60Hz, 480v (Optional).
- Suitable for Wet Locations.
- Options: 0-10 Dimming, Occupancy Sensors, Photocell and Wireless Controls Option.
- Operating Life: >60,000 hours



CONSTRUCTION

- Housing Heavy-Duty Aluminum Housing.
- 3 Mill Powder Coat Finish, (Various colors available).
- Types 2, 3, 4 and 5, Clear Optic.
- Silicone Gasket to prevent leakage and provide IP-66 Rated Product.
- Mounting: 6" or 10" Extruded Arm, Swivel Bracket, Slip Fitter, Spider or Yoke Mount, 6" Arm Wall Mount.



Optic Distribution.

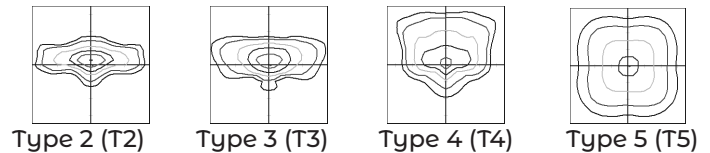

Example: CLP-3040-60CLED-T2-40K-MV-BRZ-OCC-EMR

Cat #	Wattage	Light Dist.	Color Temp.	Voltage	Color	Mounting	Options
CLP-							
CLP-3040S	10W (10CLED)	Type 2	3000K	120-277V	Black (BLK)	6" Extruded Arm (EA6)	Motion Sensor (OCC)
	20W (20CLED)	(T2)	(30K)	(MV)	White (WH)	10" Extruded Arm (EA10)	Button Photo Cell (PC)
	30W (30CLED)	Type 3	4000K	480V	White (WH)		
CLP3040M	40W (40CLED)	(T3)	(40K)	(HV)	Bronze (BRZ)	Slip Fitter (Over 2" 3/8 O.D)	Emergency Battery (EMR)
	60W (60CLED)	Type 4	5000K		Silver (SIL)	Swivel Bracket (SB)	House Side Shield (HSS)
	80W (80CLED)	(T4)	(50K)		Graphite (GPH)	Spider Mount (Over 3" O.D)	Wireless Control (WC)
	100W (100CLED)	Type 5			Marine Grade (MG)		
	120W (120CLED)	(T5)			Custom (CST)	Yoke Mount (Over 3" O.D)	
CLP-3040L	130W (130CLED)						
	150W (150CLED)					6" Extruded Arm Wall Mount (EA6WM)	
	200W (200CLED)						
	250W (250CLED)						
	300W (300CLED)						

Mounting

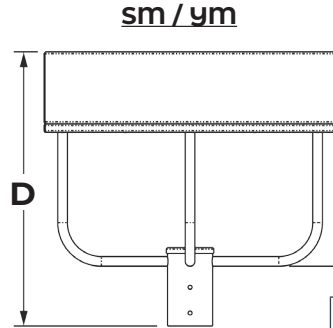
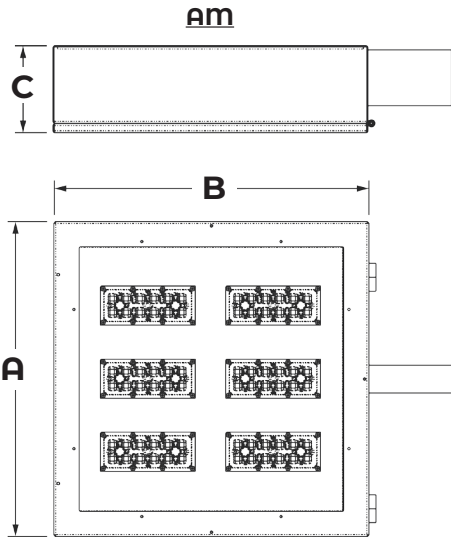
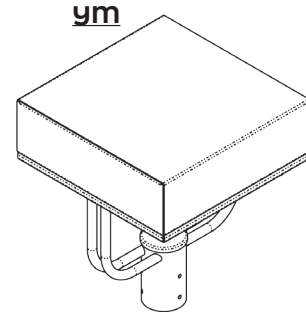
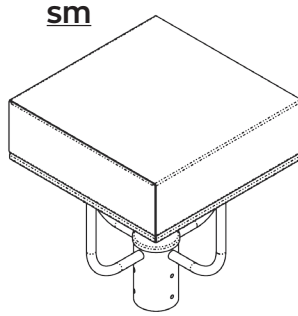
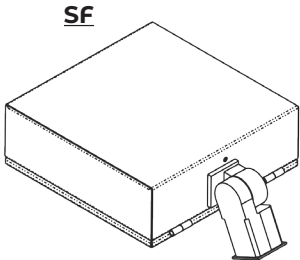
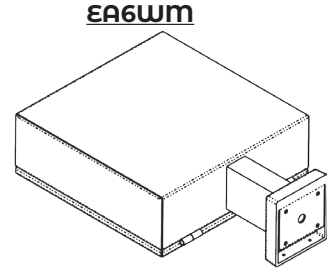
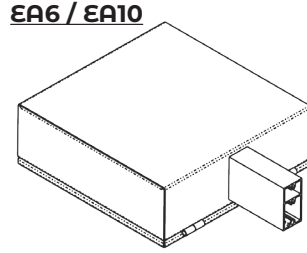
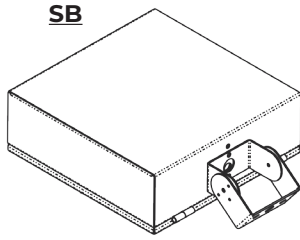

Dimensions					Am	sm / ym
Cat#	A	B	C	D	EPA	EPA
CLP-3040S	12" 1/2	12" 1/2	5" 1/4	21" 1/4	.45	.55
CLP-3040M	16" 1/4	16" 1/4	5" 1/2	19"	.62	.75
CLP-3040L	22" 5/8	22" 5/8	6" 1/4	17"	.98	1.1

Cat #	Input Power	Lumen Output	LPW	Color Temp. (CCT)	CRI	Rated Life (L70)	Input Voltage	HID Equivalent	HID Equivalent
CLP-3040S-10CLED	15W	1,938	189	5000K	70+	>200,000	120-277V	50/60HZ	35W MH
CLP-3040S-20CLED	25W	3,650	182	5000K	70+	>200,000	120-277V	50/60HZ	50W HPS
CLP-3040S-30CLED	35W	5,222	174	5000K	70+	>200,000	120-277V	50/60HZ	70W PSMH
CLP-3040S-40CLED	45W	6,492	162	5000K	70+	>200,000	120-277V	50/60HZ	150W HPS
CLP-3040M-50CLED	55W	7,320	146	5000K	70+	>200,000	120-277V	50/60HZ	150W HPS
CLP-3040M-60CLED	65W	8,320	136	5000K	70+	>200,000	120-277V	50/60HZ	250W HPS
CLP-3040M-80CLED	85W	10,340	129	5000K	70+	>200,000	120-277V	50/60HZ	250W MH
CLP-3040M-100CLED	105W	14,640	146	5000K	70+	>200,000	120-277V	50/60HZ	400W PSMH
CLP-3040M-120CLED	125W	16,984	141	5000K	70+	>200,000	120-277V	50/60HZ	400W HPS
CLP-3040M-130CLED	135W	20,238	155	5000K	70+	>200,000	120-277V	50/60HZ	400W HPS
CLP-3040L-150CLED	155W	20,680	137	5000K	70+	>200,000	120-277V	50/60HZ	400W HPS
CLP-3040L-200CLED	205W	30,020	150	5000K	70+	>200,000	120-277V	50/60HZ	750W PSMH
CLP-3040L-250CLED	255W	36,600	146	5000K	70+	>200,000	120-277V	50/60HZ	1000W MH
CLP-3040L-300CLED	305W	43,620	145	5000K	70+	>200,000	120-277V	50/60HZ	1000W HPS

Proudly Manufactured and Assembled in the USA